



# Gynaecology

Clamps	90
Forceps	90
Biopsy Forceps	94
Cervical Forceps	97
Obstetric Forceps	98
Speculum	99
Retractors	101
Curettes	103
Catheters	104
Scissors	106
Miscellaneous	107
Dilators and Sounds	108

# Clamps and Forceps



FOR INFORMATION ON  
BLACK AND GOLD BOWS  
SEE PAGE 23

## Parametrium Clamp Forceps

Hysterectomy clamp, atraumatic jaws, two gold bows

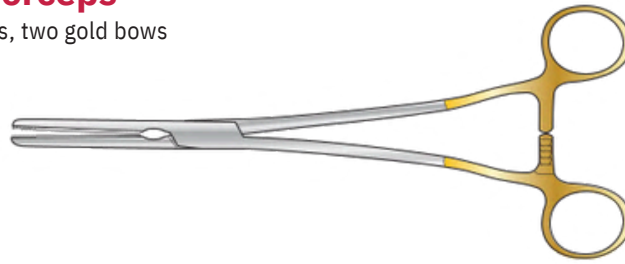

**Straight**

Code	Description
SC-GY/078	203mm long
SC-GY/078a	233mm long
SC-GY/078b	254mm long
SC-GY/078c	304mm long
SC-GY/078d	360mm long



**Slight curve**

Code	Description
SC-GY/078e	203mm long
SC-GY/078f	233mm long
SC-GY/078g	254mm long
SC-GY/078h	304mm long
SC-GY/078i	360mm long



**Strong curve**

Code	Description
SC-GY/078j	203mm long
SC-GY/078k	233mm long
SC-GY/078L	254mm long
SC-GY/078n	360mm long



**Angled**

Code	Description
SC-GY/078o	203mm long
SC-GY/078p	233mm long
SC-GY/078q	254mm long
SC-GY/078r	304mm long
SC-GY/078s	360mm long

## Spencer-Robarts Clamp

For endometrial and pedunculated fibroid polyps, with ratchet jaw-locking mechanism, and 50° jaw opening



Code	Description
SC-GY/082	Shaft 235mm long

## Museux Vulsellum Forceps

Matt finish

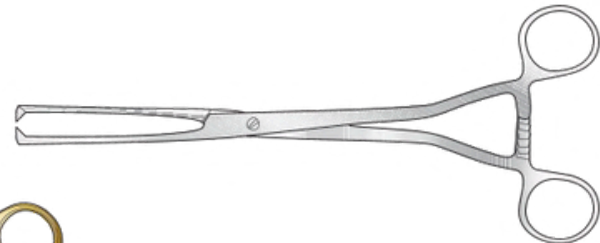

Code	Description
SC-GY/123	240mm long



## Schroeder Uterine Vulsellum Forcep

1-1 teeth

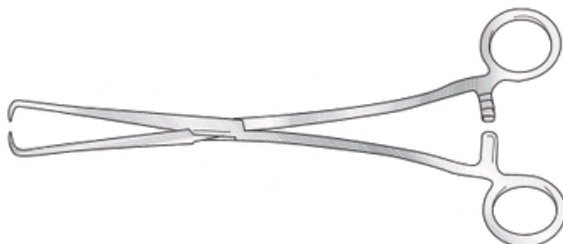

Code	Description
SC-GY/022	229mm long

## Teale Uterine Vulsellum Forcep

3-4 teeth, 230mm long



Code	Description
SC-GY/023	Curved
SC-GY/023a	Straight

## Bonney Hysterectomy Forceps

Angled on flat, 1 - 2 teeth



Code	Description
SC-GY/018	197mm long

## Maingot Hysterectomy Forceps

203mm long

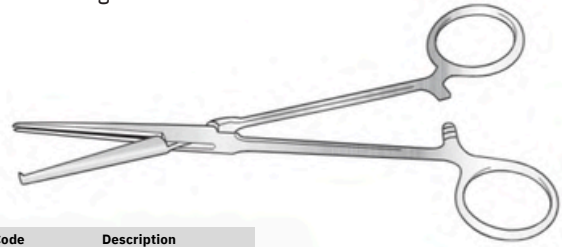

Code	Description
SC-GY/017a	Curved on flat, 1 - 2 teeth
SC-GY/017b	Straight

## Berkeley-Bonney Hysterectomy Forceps

Curved on flat, 1 - 2 teeth



Code	Description
SC-GY/019	203mm long

## Faures Peritoneum Forceps

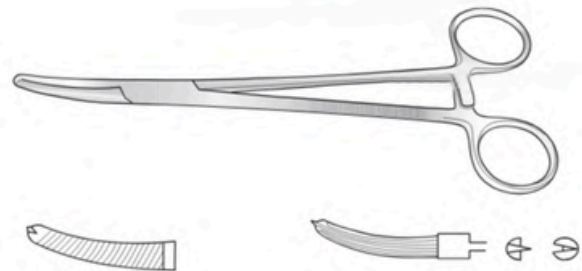

205mm long

Code	Description
SC-GY/146	Slight curve

203mm long, longitudinal serrations

Code	Description
SC-GY/5146	Curved, toothed
SC-GY/5146a	Curved

## Gwilliam Hysterectomy Forceps

Longitudinal serrations 203mm long

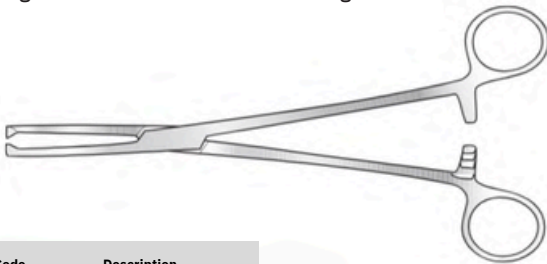

Code	Description
SC-GY/003a	Straight,
SC-GY/003b	Curved on flat, 1-2 teeth

## Heaney Hysterectomy Forceps

Curved on flat, 203mm long

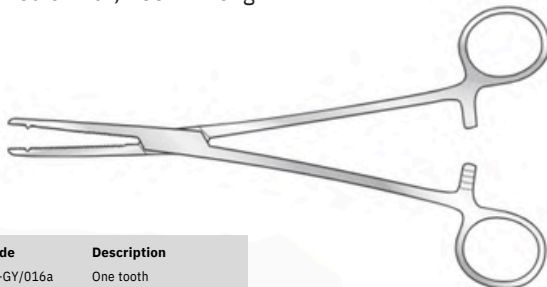

Code	Description
SC-GY/016a	One tooth
SC-GY/016b	Double tooth

# Forceps

## Bonney Uterine Polypus Forcep

Box joint

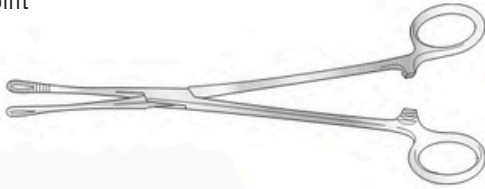

Code	Description
SC-GY/020	240mm long

## Somer Uturus Holding Forcep

Matt finish

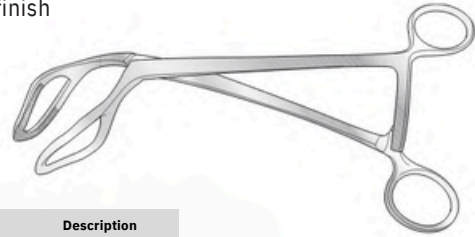

Code	Description
SC-GY/091	230mm long
SC-GY/002	254mm long

## Noto Uterine Polypus Forceps

Matt finish

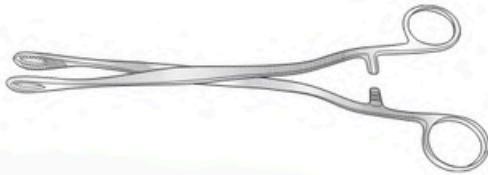

Code	Description
SC-GY/124	240mm long

## McClintock Ovum Forcep

Curved, screw joint



Code	Description
SC-GY/036	241mm long

## Vant Uterine Polypus Forcep

Serrated

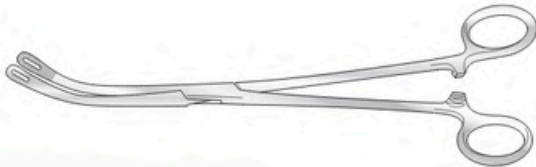

Code	Description
SC-GY/021	240mm long

## Greenhalgh Ovum Forcep

Screw joint



Code	Description
SC-GY/037	240mm long

## Dartigues Uterine Forceps

Matt finish

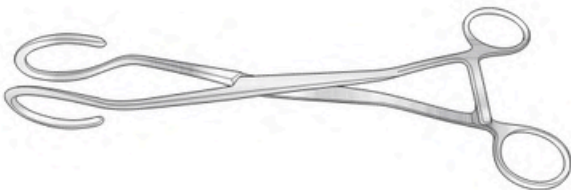

Code	Description
SC-GY/090	270mm long

## Keily Ovum Forceps

Matt finish

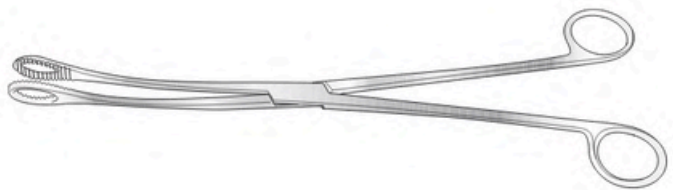

Code	Description
SC-GY/111	320mm long



FOR INFORMATION ON  
BLACK AND GOLD BOWS  
SEE PAGE 23

## Doyen Ovarian Forceps

Matt finish



Code	Description
SC-GY/118	210mm long

## Lowa Tenaculum Forceps

Matt finish, 5-6 teeth



Code	Description
SC-GY/094	260mm long



## Wertheim Parametrium Forcep

Curved on flat, screw joint



Code	Description
SC-GY/005	254mm long

## Skene Tenaculum Forceps

Bright finish



Code	Description
SC-GY/120	240mm long

## Green-Armytage Haemostasis Forcep

Screw joint, 15mm jaw, 210mm long



Code	Description
SC-GY/029a	Straight
SC-GY/029b	Angled

## Pratt Tenaculum Forceps

Matt finish

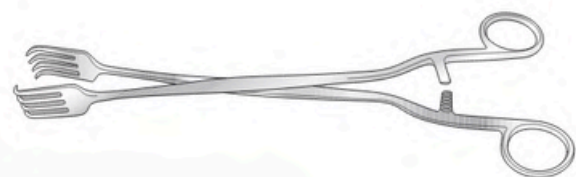

Code	Description
SC-GY/095	280mm long

## Kogan Endocervical Forceps

Matt finish, 275mm long

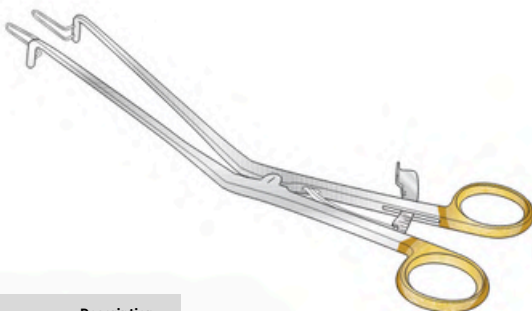

Code	Description
SC-GY/131	3mm jaw
SC-GY/131a	5mm jaw
SC-GY/131b	7mm jaw

## Coil Removing Forcep

With serrated rounded jaws 4mm wide

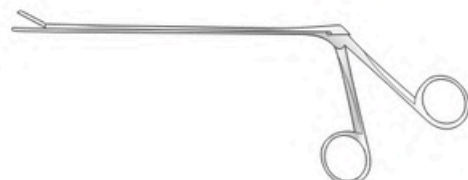

Code	Description
SC-GY/075	160mm to shoulder

# Forceps and Biopsy Forceps

## Willet Martel Forceps

Matt finish

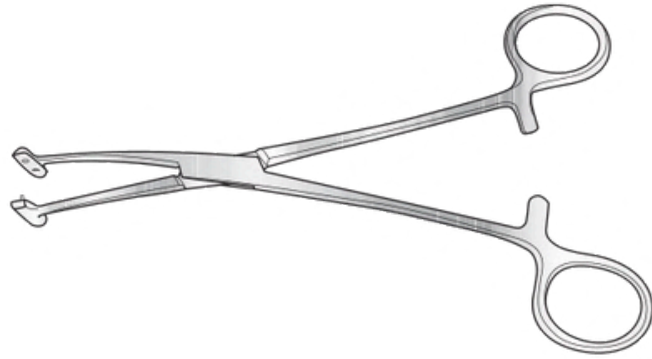

Code	Description
SC-GY/121	190mm long

## Littlewood Tissue Forceps

2-3 teeth, matt finish

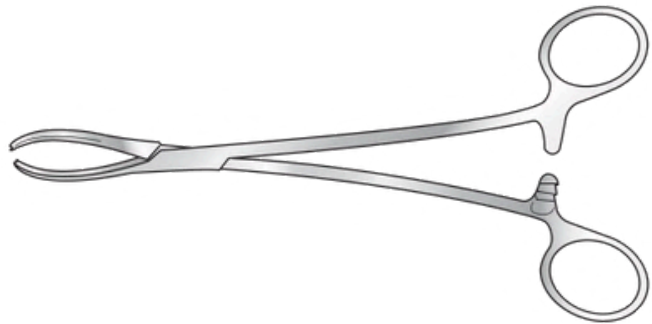

Code	Description
SC-GY/275	190mm long

## Eppendorf Biopsy Punch Forcep

200mm to shoulder

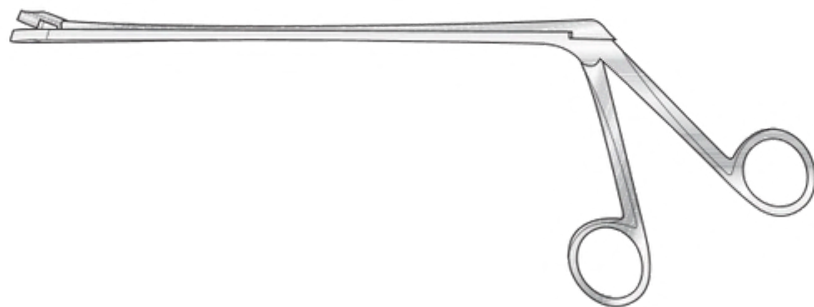

Bite shown actual size

Code	Description
SC-GY/14-314-200	3mm x 8mm bite



FOR INFORMATION ON  
BLACK AND GOLD BOWS  
SEE PAGE 23

# Biopsy Forceps

## Kevorkian Biopsy Punch Forcep

255mm to shoulder



Bite shown actual size

Code	Description
SC-GY/14-329-250	3mm x 8mm bite

## Tischler Morgan Biopsy Forcep

210mm to shoulder

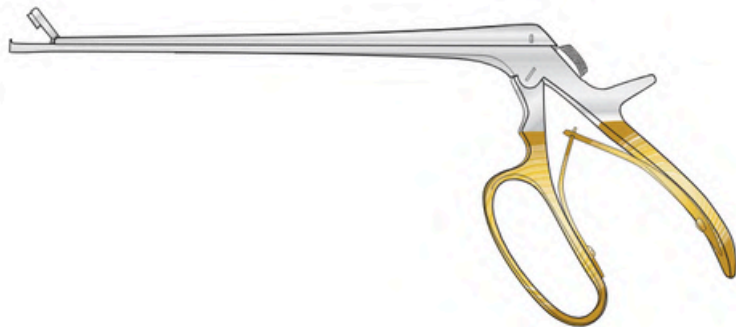

Bite shown actual size

Code	Description
SC-GY/14-328-220	3mm x 7mm bite

## Tischler Morgan Biopsy Punch Forcep

295mm to shoulder



Bite shown actual size

Code	Description
SC-GY/088	2mm x 7mm bite

# Biopsy Forceps



FOR INFORMATION ON  
BLACK AND GOLD BOWS  
SEE PAGE 23

## Baby Tischler Biopsy Forcep

210mm to shoulder

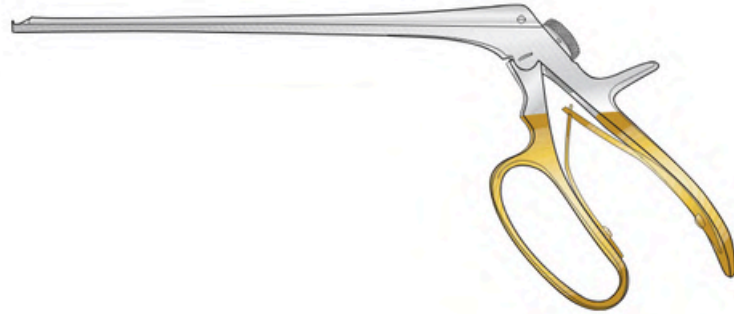

 Bite shown actual size

Code	Description
SC-GY/14-325-250	2mm x 5mm bite

## Baby Tischler Biopsy Punch Forcep

295mm to shoulder





 Bite shown actual size

Code	Description
SC-GY/087	2mm x 5mm bite

## Van Doren Biopsy Forceps

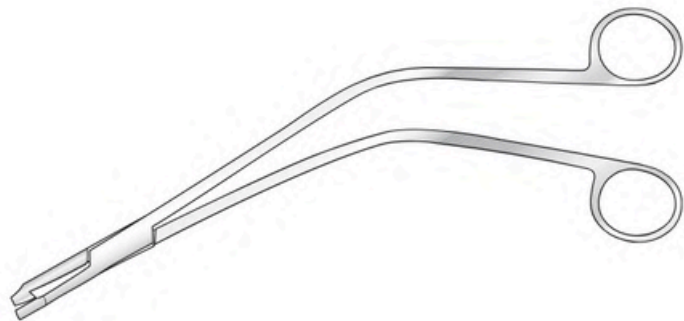
Bright finish, 260mm overall length



 Bite shown actual size

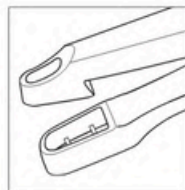

Code	Description
SC-GY/112	5mm x 9mm bite

## Van Doren Cervical Biopsy Punch Forcep

With curved basket jaw, angled shanks

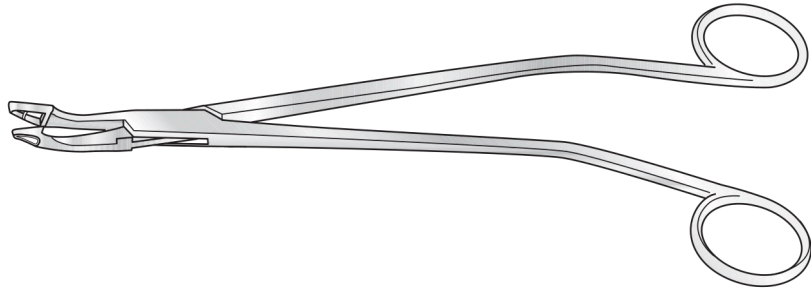

Code	Description
SC-GY/025	240mm long

## Wittner Cervical Biopsy Punch Forcep

240mm long shaft

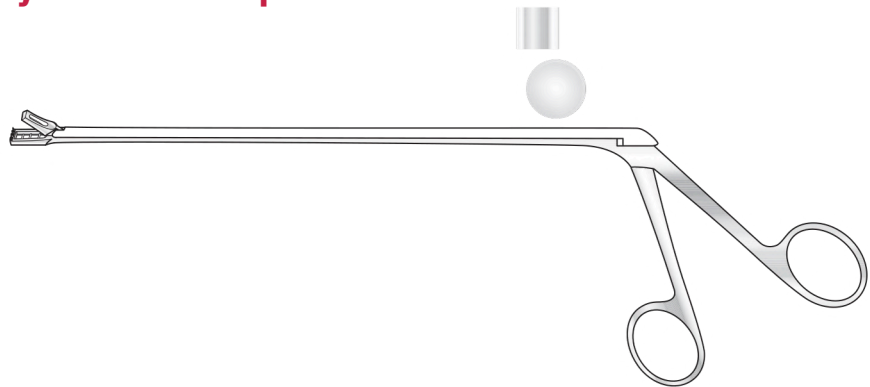

Code	Description
SC-GY/024a	Jaws curved to side
SC-GY/024b	Jaws straight to side

# Obstetric Forceps

## Barnes Obstetric Forcep

With Simpson handles and Neville axis traction rod

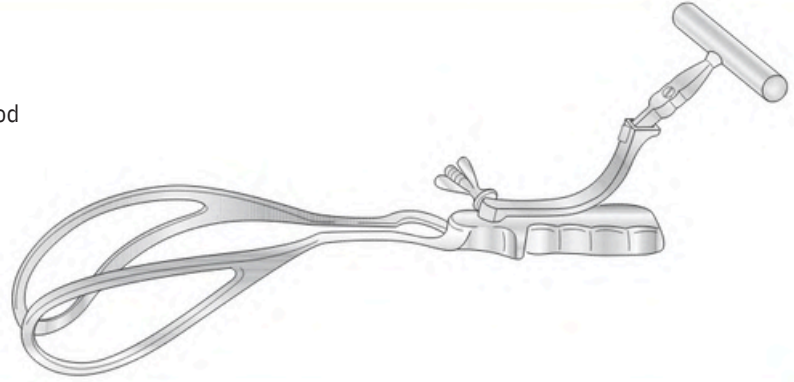

Code	Description
SC-GY/027	381mm long

## Haig Ferguson Obstetric Forcep

Tape slots in blades and axis traction rod

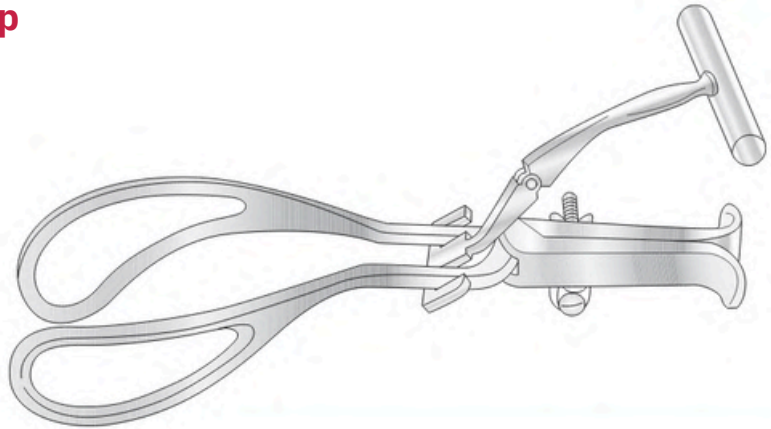

Code	Description
SC-GY/028	356mm long

## Kieland Obstetric Forcep

Matt finish

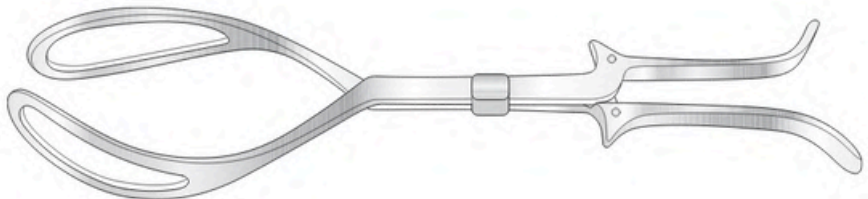

Code	Description
SC-GY/089	410mm long

## Simpson Braun Obstetric Forcep

Matt finish

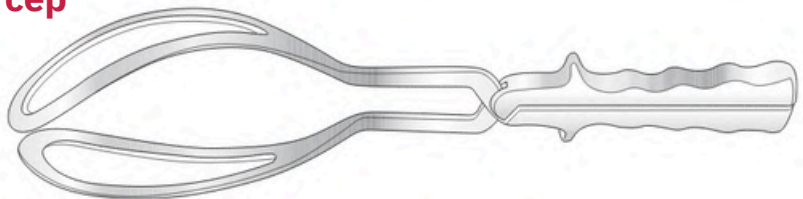

Code	Description
SC-GY/086	380mm long

## Wrigley Obstetric Forcep

Short model for caesarian section

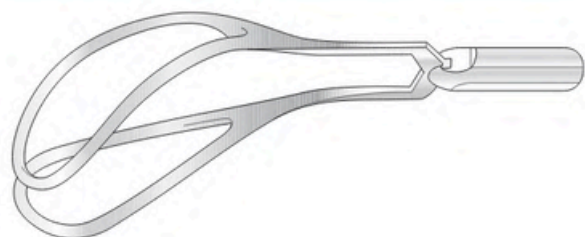

Code	Description
SC-GY/026	279mm long

## Auvard Vaginal Speculum

Weighted

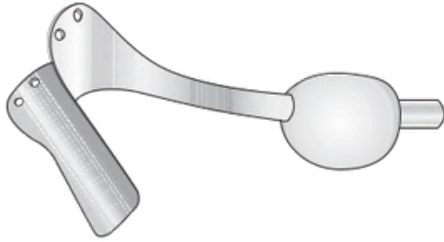

Code	Description
SC-GY/007a	Small blade 38 x 90mm
SC-GY/007b	Large blade 51 x 90mm

## Collin Vaginal Speculum

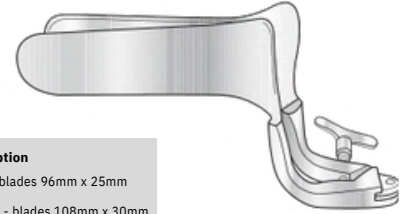

Code	Description
SC-GY/014a	Small - blades 96mm x 25mm
SC-GY/014b	Medium - blades 108mm x 30mm
SC-GY/014c	Large - blades 108mm x 35mm

## Graves Vaginal Speculum

Bright finish



Code	Description
SC-GY/103	115 x 35mm

## Nott Speculum

Stainless steel

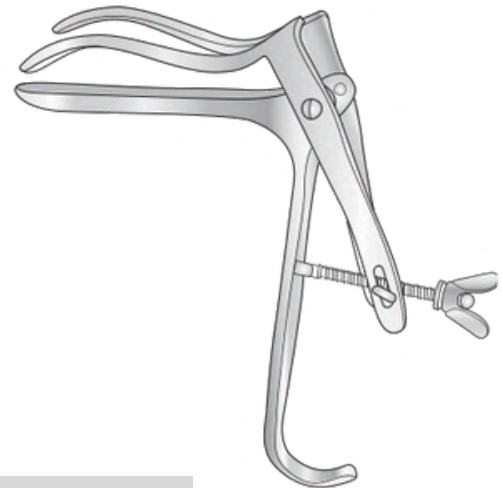

Code	Description
SC-GY/04102	Blade 110mm long, 30mm wide

## Cusco Vaginal Speculum

Stainless steel

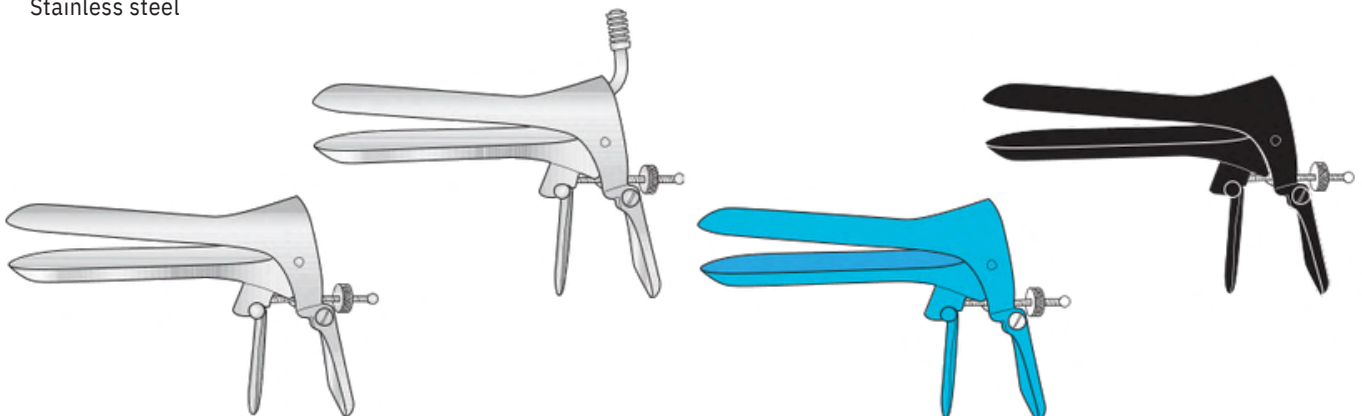

### Insulated

Code	Description	Code	Description
SC-GY/015d	Extra small - 98mm x 16mm	SC-GY/134	Small - 105mm x 25mm
SC-GY/015c	Small - 105mm x 25mm	SC-GY/135	Medium - 107mm x 29mm
SC-GY/015f	Medium - 107mm x 29mm	SC-GY/136	Large - 115mm x 35mm
SC-GY/015e	Large - 115mm x 35mm	SC-GY/137	Extra large - 135mm x 38mm

### With Suction Tube

Code	Description
SC-GY/015k	Small - 105mm x 25mm
SC-GY/015j	Medium - 107mm x 29mm
SC-GY/015i	Large - 115mm x 35mm
SC-GY/015h	Extra large - 135mm x 38mm

### Black Finish

Code	Description
SC-GY/138	Small - 105mm x 25mm
SC-GY/139	Medium - 107mm x 29mm
SC-GY/140	Large - 115mm x 35mm
SC-GY/141	Extra large - 135mm x 38mm

# Speculum

## Pederson Vaginal Speculum

Stainless steel

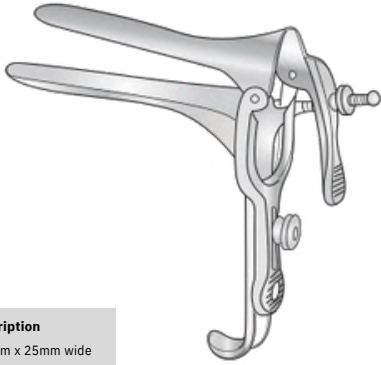

Code	Description
S C- G Y/07 8	120mm x 25mm wide
SC-GY/078a	90mm x 20mm wide

## Winterton Vaginal Speculum

Stainless steel

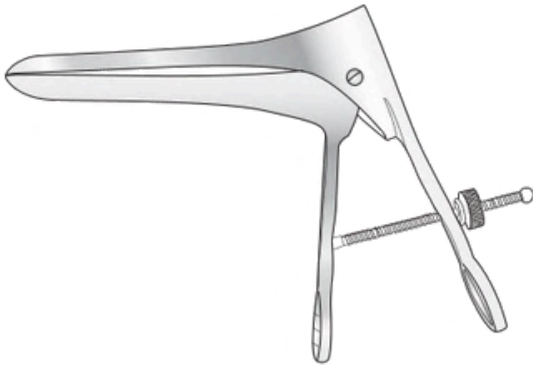

Code	Description
S C- G Y/074	Blade 115mm long, 25mm wide

## Modified Speculum

Stainless steel, for elderly patients

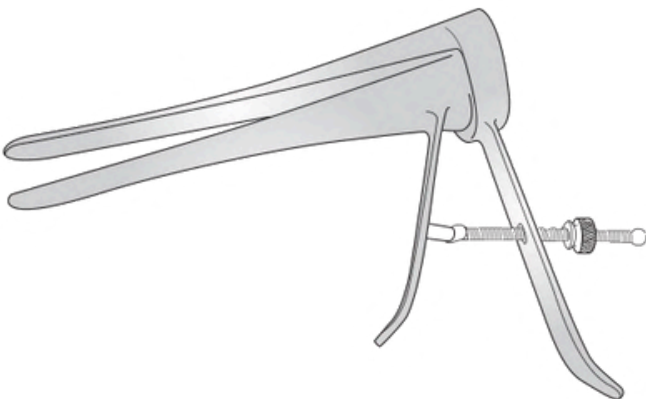

Code	Description
S C- G Y/074 a	Blade 180mm long, 18mm wide

## Sims Duckbill Speculum

Double ended



Code	Description
SC-GY/012a	Small - 27mm x 29mm x 130mm long
SC-GY/012b	Medium - 30mm x 33mm x 158mm long
SC-GY/012c	Large - 33mm x 38mm x 184mm long

## Sims Duckbill Speculum

Double ended,  
insulated



Code	Description
SC-DIA/031	Small - 27mm x 29mm x 130mm long
SC-DIA/032	Medium - 30mm x 33mm x 158mm long
SC-DIA/033	Large - 33mm x 38mm x 184mm long

## Breisky Vaginal Retractor

Bright finish, matt handle 320mm long

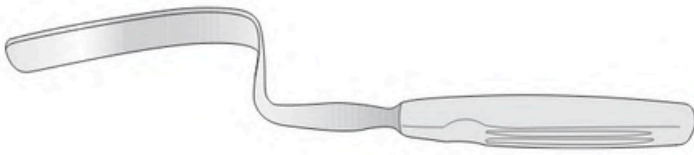

Code	Description
SC-GY/110	25mm blade

## Doyen Retractor



Code	Description
SC-GY/009b	Blade 100mm x 30mm

## Doyen Rectangular Retractor

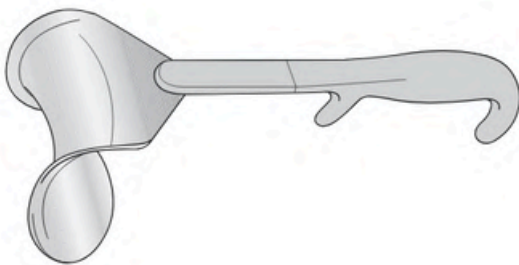

Code	Description
SC-GY/008a	Small - 48 x 60mm
SC-GY/008b	Medium - 48 x 89mm
SC-GY/008c	Large - 48 x 124mm

## St Mark's Hospital Pattern Retractor

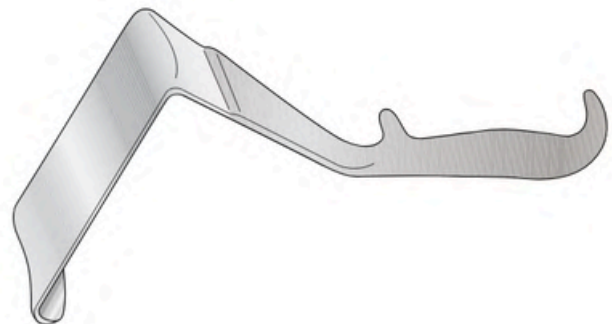

With lip

Code	Description
SC-GY/065	Blade 125mm x 60mm
SC-GY/066	Blade 175mm x 60mm

Without lip

Code	Description
SC-GY/067	Blade 125mm x 60mm
SC-GY/068	Blade 175mm x 60mm

## Doyen Retractor

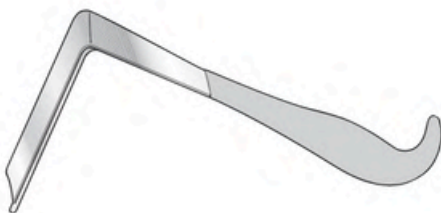

Code	Description
SC-GY/009a	Blade 95mm x 27mm

## Wertheim Retractor

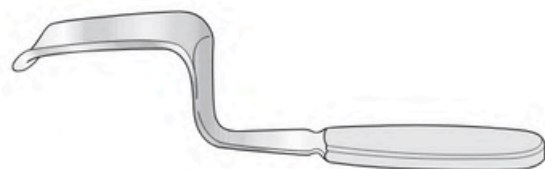

Code	Description
SC-GY/010	Blade 95mm x 38mm

# Retractors

## Landon Vaginal Retractor

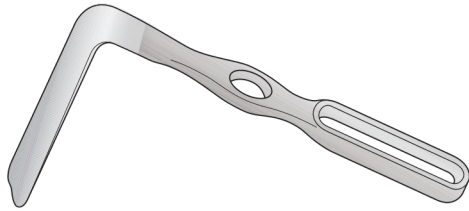

Code	Description
SC-GY/011	Blade 89mm x 25mm

## Lateral Vaginal Retractor

Blades bright finish, matt handle



Code	Description
SC-GY/128	60 x 20mm blade
SC-GY/128a	75 x 22mm blade
SC-GY/128b	110 x 23mm blade

**AVAILABLE INSULATED  
ADD SUFFIX 'INS'**

## Whitlow Retractor

Vaginal retractor, for use with supplied blades. Points of retraction move around almost 360°. Supplied complete with sterilising basket and three sets of blades.

### Frame

225mm at widest point

### Blades

1 x anterior and 1 x posterior 90°, 25mm x 100mm  
2 x lateral 90°, 25mm x 70mm  
2 x lateral 75°, 25mm x 70mm

Code
SC-GY/084

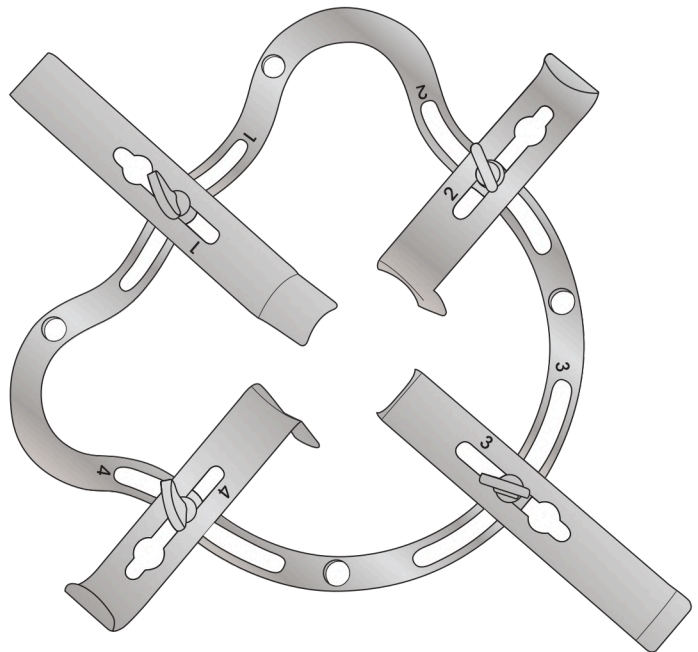
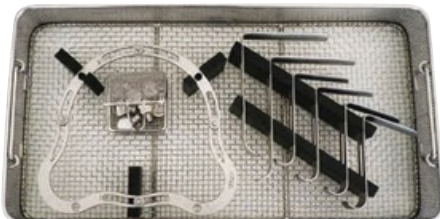

## The Genuine Bookwalter® Magrina-Retractor System

Optimized for vaginal hysterectomy, Symmetry Surgical's Bookwalter® Magrina Retractor System uses the latest Bookwalter® innovations to enhance function and stability during retraction.

Contact us for full spec and to order  
[info@stadlerinstruments.com](mailto:info@stadlerinstruments.com)

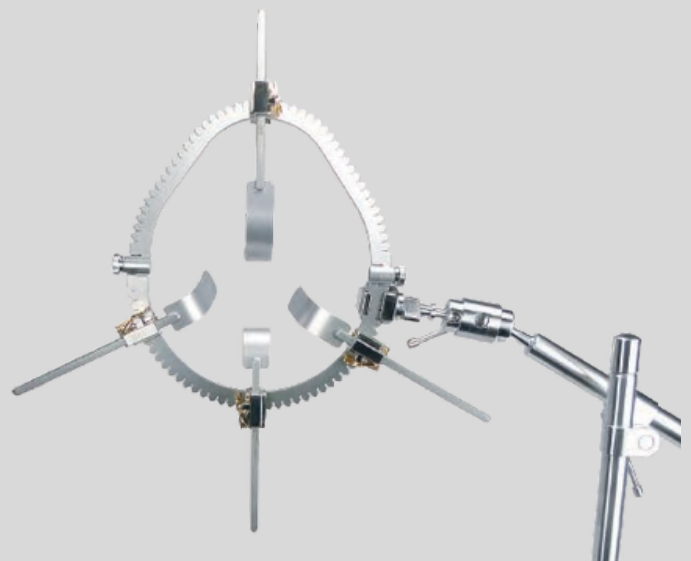

## Kevorkian Biopsy Curette

313mm long

Code	Description
SC-GY/105	With basket
SC-GY/127	Without basket

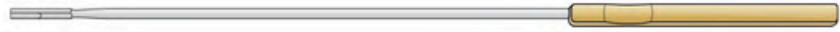

## Novak Curette

Code	Description
SC-GY/119	230mm long



## Recamier Uterine Curette

Matt finish, 310mm long

Code	Description
SC-GY/108	Blunt
SC-GY/109	Sharp



## Rheinstadter Flushing Curette

290mm long

**Sharp**

Code	Description
SC-GY/076a	Sharp, 8mm
SC-GY/076b	Sharp, 14mm

**Blunt**

Code	Description
SC-GY/076c	Blunt, 8mm
SC-GY/076d	Blunt, 14mm



## Sims Uterine Curette

Single ended, 255mm long, matt finish

**Sharp**

Code	Description
SC-GY/075a	Small 6mm
SC-GY/075b	Medium 10mm
SC-GY/075c	Large 13mm

**Blunt**

Code	Description
SC-GY/075d	Small 6mm
SC-GY/075e	Medium 10mm
SC-GY/075f	Large 13mm



## Sims Uterine Curette

Double ended, 250mm long

**Sharp**

Code	Description
SC-GY/044	Small 7 x 5mm
SC-GY/045	Medium 10 x 7mm
SC-GY/046	Large 13 x 10mm

**Blunt**

Code	Description
SC-GY/047	Small 7 x 5mm
SC-GY/048	Medium 10 x 7mm
SC-GY/049	Large 13 x 10mm



# Catheters

## Rotunda Hospital Pattern Catheter

With solid end, chromium plated, 203mm long



Code	Description
SC-GY/035a	8 E.G.
SC-GY/035b	10 E.G.

## Catheter

Oval, solid end, chromium plated



Code	Description
SC-GY/034	165mm long

## Catheter Introducer

457mm long



Code	Description
SC-GY/071	Straight, 2mm ø
SC-GY/071a	Curved, 2mm ø

## Catheter Introducer



Code	Description
SC-GY/071b	Fine, 395mm long

## Catheter Introducer

Bulbous end, with eye in handle



Code	Description
SC-GY/071c	Curved, 2mm x 410mm long

## Catheter Introducer

With eye in handle, curved



Code	Description
SC-GY/071d	2mm x 420mm long

## Catheter Introducer

Fixed handle



Code	Description
SC-GY/071e	445mm long

## Catheter Introducer



Code	Description
SC-GY/071f	400mm long

## Catheter Introducer

410mm long

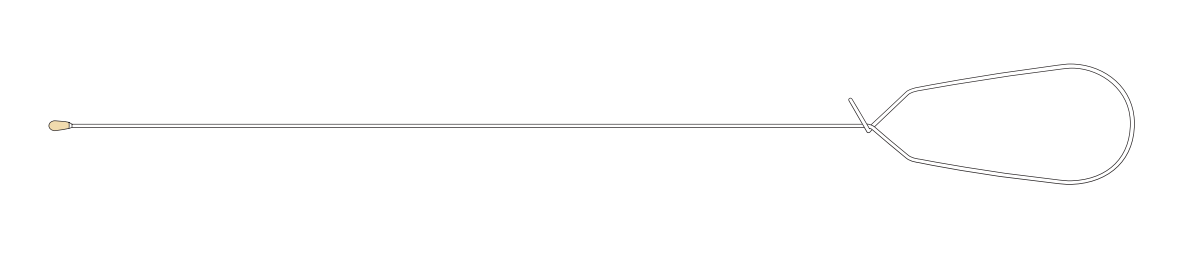

Code	Description
SC-GY/071g	410mm long

# Scissors



FOR INFORMATION ON  
BLACK AND GOLD BOWS  
SEE PAGE 23

## Barnes Episiotomy Scissors



Code	Description
SC-GY/032	127mm long

## Braun Stadler Episiotomy Scissors

Matt finish

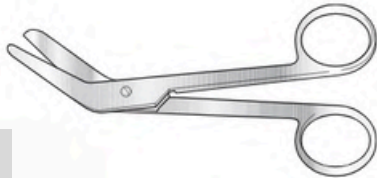

Code	Description
SC-GY/063	140mm long
SC-GY/064	222mm long

## Vant Episiotomy Scissors



Code	Description
SC-GY/033	76mm blades, 241mm long

## Busch Umbilical Scissors

Matt finish



Code	Description
SC-GY/116	160mm long

## Umbilical Scissors

American pattern



Code	Description
SC-GY/031	102mm long

## Simms Uterine Scissors

Curved, tungsten carbide, with two gold bows

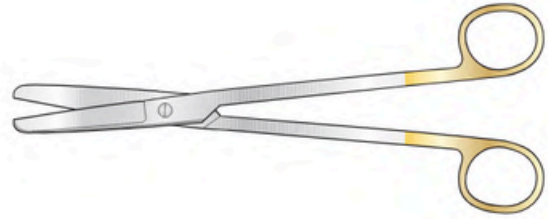

Code	Description
SC-GY/115	200mm long



## Dubois Uterine Scissors

Matt finish

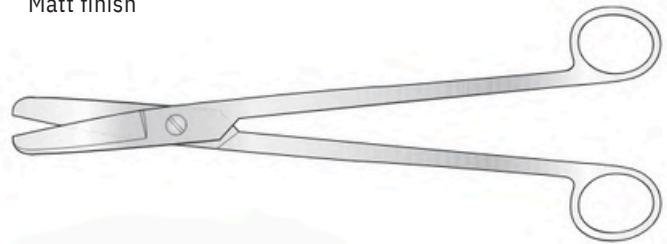

Code	Description
SC-GY/114	270mm long

## Uterine Scissors

Curved on flat



Code	Description
SC-GY/030a	203mm long

## Uterine Scissors

Angled on flat



Code	Description
SC-GY/030b	230mm long



FOR INFORMATION ON  
BLACK AND GOLD BOWS  
SEE PAGE 23

# Scissors and Miscellaneous

## Parametrium Scissors

225mm long

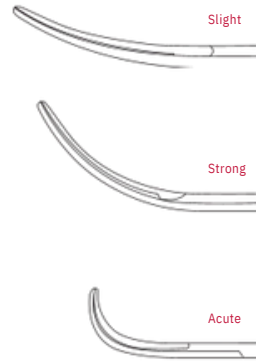
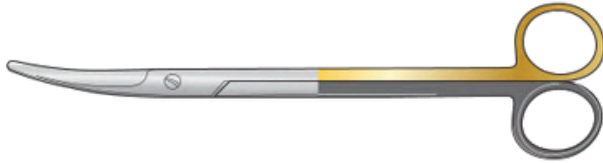

**Tungsten carbide, standard,  
with two gold bows**

Code	Description
SC-GY/080	Slight curve
SC-GY/080a	Strong curve
SC-GY/080b	Acute curve

**Tungsten carbide, supercut,  
with one gold and one black bow**

Code	Description
SC-GY/081	Slight curve
SC-GY/081a	Strong curve
SC-GY/081b	Acute curve

## Miscellaneous

### Bonney Myomectomy Clamp

With 51mm jaws, screw joint

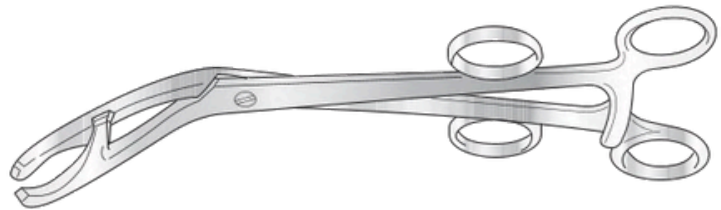

Code	Description
SC-GY/004	267mm long

### Sims Vaginal Depressor

Double ended



Code	Description
SC-GY/039	260mm long

### Spackman Uterine Cannula

Chrome plated, 360mm long



Code	Description
SC-GY/040	12 F.G. with rubber cone
SC-GY/040a	14 F.G. with metal cone
SC-GY/040b	14 F.G. with rubber cone
SC-GY/040c	18 F.G. with metal cone
SC-GY/040d	18 F.G. with rubber cone

### Doyen Myoma Screw Large



Code	Description
SC-GY/006a	178mm long

### Doyen Myoma Screw Small



Code	Description
SC-GY/006b	178mm long

# Dilators and Sounds

## Galabin Uterine Sound

Calibrated 4-24, bright finish



Code	Description
SC-GY/106	305mm long

## Sims Uterine Sound

Calibrated 4-24, bright finish



Code	Description
SC-GY/107	320mm long

## Umbilical Dilator



Code	Description
SC-GY/038	95mm long

## Hegar Cervix Dilator

Single ended, 185mm long



Code	Description
SC-GY/70SE1	1mm ø
SC-GY/70SE2	2mm ø
SC-GY/70SE3	3mm ø
SC-GY/70SE4	4mm ø
SC-GY/70SE5	5mm ø
SC-GY/70SE6	6mm ø
SC-GY/70SE7	7mm ø
SC-GY/70SE8	8mm ø
SC-GY/70SE9	9mm ø

Code	Description
SC-GY/70SE10	10mm ø
SC-GY/70SE11	11mm ø
SC-GY/70SE12	12mm ø
SC-GY/70SE13	13mm ø
SC-GY/70SE14	14mm ø
SC-GY/70SE15	15mm ø
SC-GY/70SE16	16mm ø
SC-GY/70SE17	17mm ø

## Hawkin Ambler Cervix Dilators

Conical, 171mm long



Code	Description
SC-GY/050	Set of 12
SC-GY/051	Size 3 - 6mm
SC-GY/052	Size 4 - 7mm
SC-GY/053	Size 5 - 8mm
SC-GY/054	Size 6 - 9mm
SC-GY/055	Size 7 - 10mm
SC-GY/056	Size 8 - 11mm

Code	Description
SC-GY/057	Size 9 - 12mm
SC-GY/058	Size 10 - 13mm
SC-GY/059	Size 11 - 14mm
SC-GY/060	Size 12 - 15mm
SC-GY/061	Size 13 - 16mm
SC-GY/062	Size 14 - 17mm

## Hegar Cervix Dilator

Double ended, 200mm long



Code	Description
SC-GY/070j	Set of 8: from sizes 1 and 2mm to 15 and 16mm
SC-GY/070h	1 and 2mm ø
SC-GY/070i	3 and 4mm ø
SC-GY/070a	5 and 6mm ø
SC-GY/070b	7 and 8mm ø

Code	Description
SC-GY/070c	9 and 10mm ø
SC-GY/070d	11 and 12mm ø
SC-GY/070e	13 and 14mm ø
SC-GY/070f	15 and 16mm ø
SC-GY/070g	17 and 18mm ø