



Diathermy/ Bipolar

Diathermy Scissors	55
Diathermy Forceps	55
Bipolar Forceps	56
Handles, Needles and Blades	57
Leads	58
Quivers	58

Diathermy Scissors and Forceps

Turner Warwick Diathermy Scissors

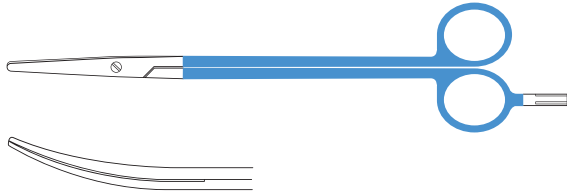

Straight

Code	Description
SC-DIA/072	190mm long
SC-DIA/073	230mm long
SC-DIA/074	250mm long

Curved

Code	Description
SC-DIA/075	190mm long
SC-DIA/076	230mm long
SC-DIA/077	250mm long

Riches Artery Forceps

Screw joint, curved

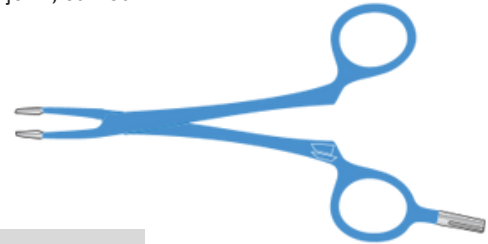

Code	Description
SC-DIA/014	127mm long
SC-DIA/015	152mm long
SC-DIA/016	178mm long
SC-DIA/017	185mm long
SC-DIA/018	228mm long

Adson Forceps

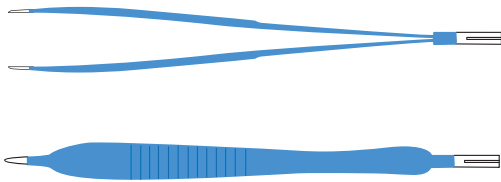

Code	Description
SC-DIA/003	152mm long

Wilson Hey Artery Forceps

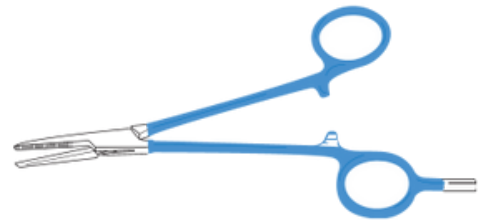

Straight

Code	Description
SC-DIA/023	152mm long
SC-DIA/024	178mm long
SC-DIA/025	185mm long
SC-DIA/026	228mm long

Curved

Code	Description
SC-DIA/019	152mm long
SC-DIA/020	178mm long
SC-DIA/021	185mm long
SC-DIA/022	228mm long

Dissecting Forceps

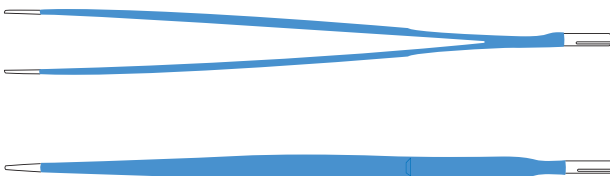

Serrated

Code	Description
SC-DIA/004	152mm long
SC-DIA/005	178mm long
SC-DIA/006	203mm long
SC-DIA/007	228mm long
SC-DIA/008	254mm long

1-2 teeth

Code	Description
SC-DIA/009	152mm long
SC-DIA/010	178mm long
SC-DIA/011	203mm long
SC-DIA/012	228mm long
SC-DIA/013	254mm long

Did you know...

The difference between Monopolar Electrosurgery and Bipolar Electrosurgery

There is one basic difference between bipolar and monopolar techniques. With monopolar electrosurgery, a probe electrode is used to apply the electrosurgical energy to the target tissue to achieve the desired surgical effect. The current then passes through the patient to a return pad and then back to the ESU generator to complete the circuit.

With the bipolar electrosurgical method a bipolar device, often a set of forceps, is used. The electrical current passes from one side of the forcep, through the target tissue to the other side of the forcep, then back to the generator. The electrical current is restricted to the tissue between the forcep, therefore not requiring the use of a grounding pad.

Bipolar Forceps

Bipolar Forceps

Straight

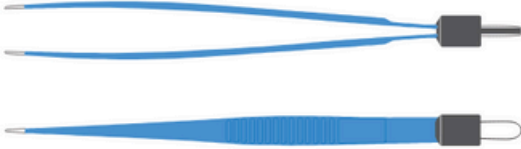

Fine tip

Code	Description
SC-DIA/034	101mm long
SC-DIA/035	127mm long
SC-DIA/036	152mm long
SC-DIA/037	178mm long
SC-DIA/038	185mm long

Medium tip

Code	Description
SC-DIA/039	101mm long
SC-DIA/040	127mm long
SC-DIA/041	152mm long
SC-DIA/042	178mm long
SC-DIA/043	185mm long

Heavy tip

Code	Description
SC-DIA/044	101mm long
SC-DIA/045	127mm long
SC-DIA/046	152mm long
SC-DIA/047	178mm long
SC-DIA/048	185mm long

Bipolar Forceps

Angled

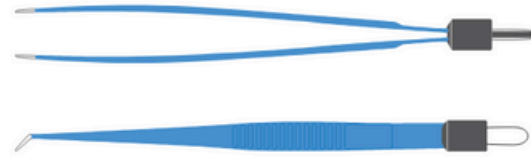

Fine tip

Code	Description
SC-DIA/049	101mm long
SC-DIA/050	127mm long
SC-DIA/051	152mm long
SC-DIA/052	178mm long
SC-DIA/053	185mm long

Medium tip

Code	Description
SC-DIA/054	101mm long
SC-DIA/055	127mm long
SC-DIA/056	152mm long
SC-DIA/057	178mm long
SC-DIA/058	185mm long

Heavy tip

Code	Description
SC-DIA/059	101mm long
SC-DIA/060	127mm long
SC-DIA/061	152mm long
SC-DIA/062	178mm long
SC-DIA/063	185mm long

Adson Bipolar Forceps

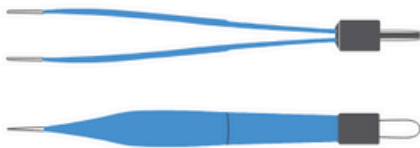

Code	Description
SC-DIA/003a	152mm long

Monel Handle



Code	Description
SC-DIA/028	145mm long

Monel Blade



Code	Description
SC-DIA/029	Fully insulated
SC-DIA/030	Non-insulated

Needle Handles



Code
SC-DIA/027

Needles

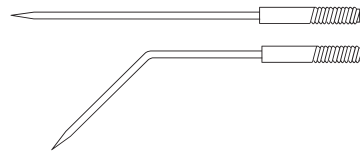

Straight

Code	Description
SC-DIA/064	Stout
SC-DIA/064a	Medium

Angled

Code	Description
SC-DIA/064b	Stout
SC-DIA/064c	Medium

Abbey Diathermy Needle

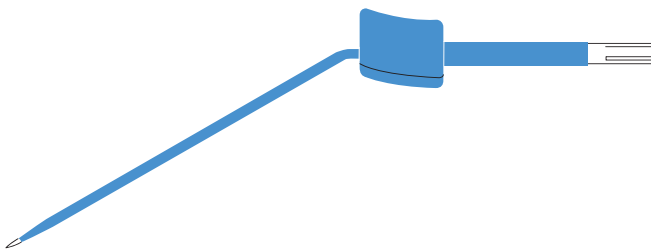

Code
SC-DIA/078

Diathermy Arm

With ball



Code	Description
SC-DIA/069	Curved
SC-DIA/069a	Straight

Finger Switch Pencil

With spatula and 3 metre lead



Code
SC-DIA/068

Spatula Blade

For diathermy finger



Code
SC-DIA/067a

Needle Point

For diathermy finger



Code
SC-DIA/067b

Leads and Quivers

Leads

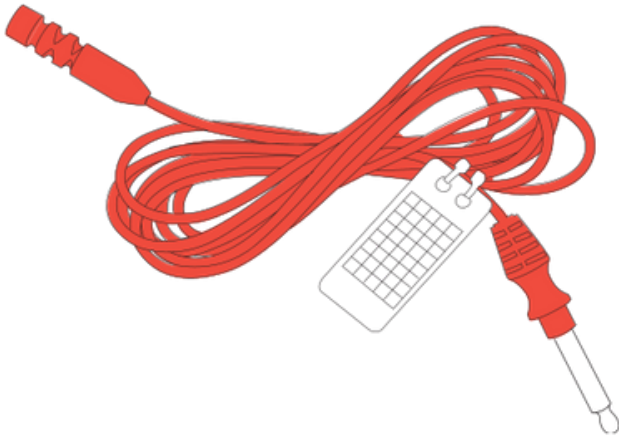

Code	Description
SC-DIA/065	4mm plug end
SC-DIA/066	8mm plug end

Bipolar Leads

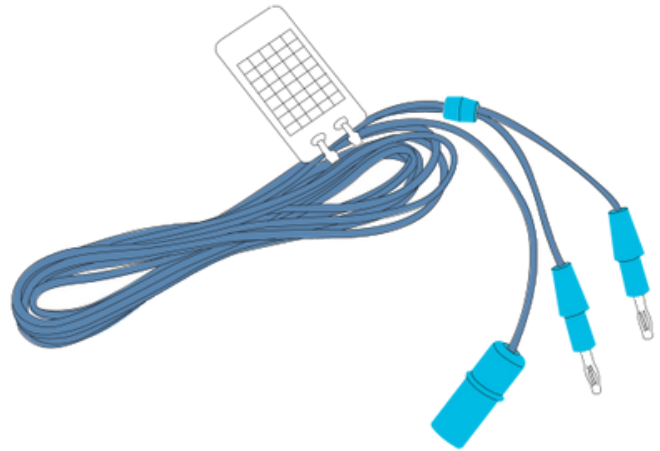

Code	Description
SC-DIA/067	Standard

Quiver

With hole in end, 232mm long

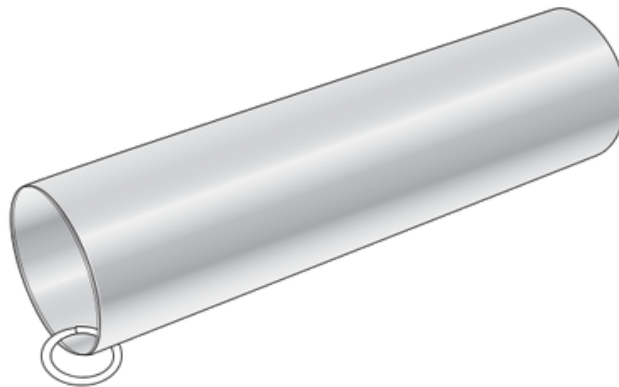

Code	Description
SC-DIA/001	Standard

Quiver

With hole in end, 232mm long

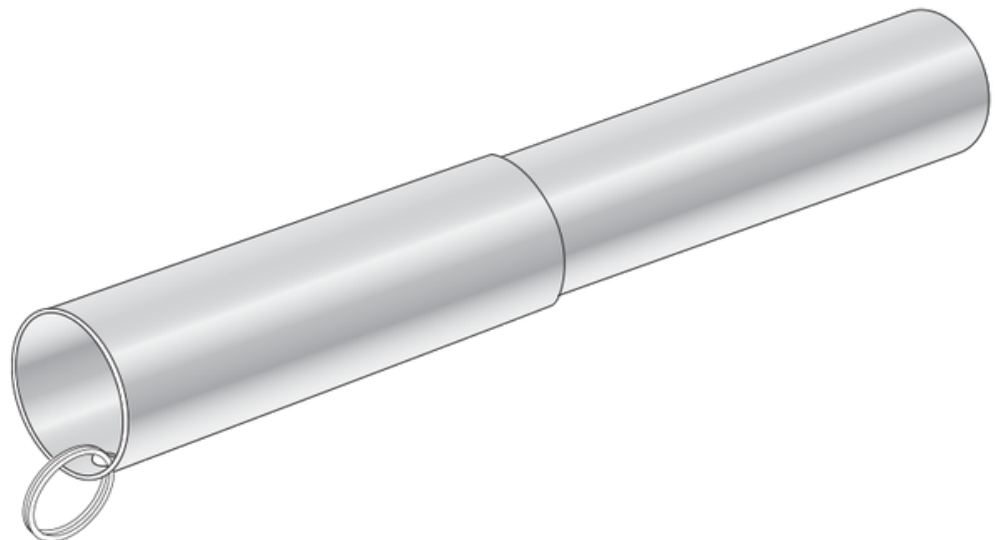

Code	Description
SC-DIA/002	Telescopic